

3290

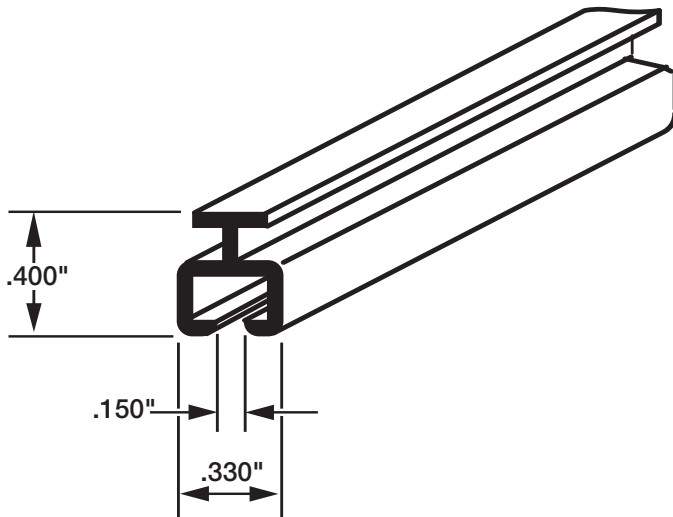

The unique SILENT GLIDE™ Curtain Track combines the functionality of a channel track with the mounting options of an I-Beam track. Excellent for lightweight applications and offers a wide range of carrier options. Manufactured from high grade aluminum, and anodized with a satin finish. Track can be bent down to a four inch radius. One way or two way hand draw.

INSTALLATION OPTIONS

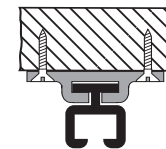

PART NO. 4126 REQUIRED

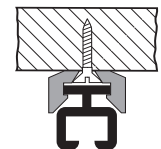

PART NO. 3082 REQUIRED

CEILING MOUNT

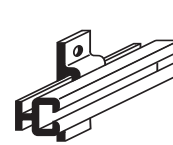



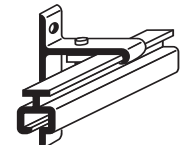





PART NO. 4126 REQUIRED

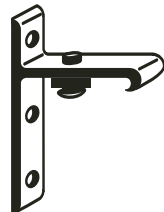

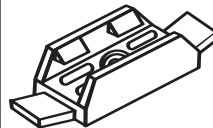
PART NO. 4124 OR 4144 REQUIRED

WALL MOUNT

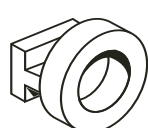
PART #	FINISH	LENGTH	STANDARD PACK
3290	(8) Clear Anodized	7 ft.	15
3291 (Custom Order)	(8) Clear Anodized, (84) Black Anodized	12 ft.	50

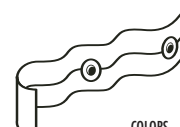
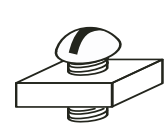
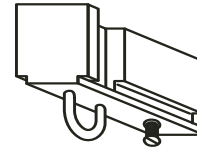
WALL BRACKET	CEILING BRACKET	CEILING SPLICER	SNAP IN RETAINER CATCH	T-GLIDE WITH ELASTIC	SEW-ON TAIL SLIDE																																																												
 <table border="1"> <thead> <tr> <th>PART #</th> <th>DESCRIPTION</th> <th>QTY.</th> </tr> </thead> <tbody> <tr> <td>4124</td> <td>1 1/4 in. projection, Bag</td> <td>2</td> </tr> <tr> <td>4125</td> <td>1 1/4 in. projection, Bulk</td> <td>100</td> </tr> <tr> <td>4144</td> <td>2 3/8 in. projection, Bag</td> <td>2</td> </tr> <tr> <td>4145</td> <td>2 3/8 in. projection, Bulk</td> <td>100</td> </tr> </tbody> </table> <p>Material: Aluminum</p>	PART #	DESCRIPTION	QTY.	4124	1 1/4 in. projection, Bag	2	4125	1 1/4 in. projection, Bulk	100	4144	2 3/8 in. projection, Bag	2	4145	2 3/8 in. projection, Bulk	100	 <table border="1"> <thead> <tr> <th>PART #</th> <th>DESCRIPTION</th> <th>QTY.</th> </tr> </thead> <tbody> <tr> <td>4126</td> <td>Aluminum, Bag</td> <td>2</td> </tr> <tr> <td>4127</td> <td>Aluminum, Bulk</td> <td>100</td> </tr> </tbody> </table>	PART #	DESCRIPTION	QTY.	4126	Aluminum, Bag	2	4127	Aluminum, Bulk	100	 <table border="1"> <thead> <tr> <th>PART #</th> <th>DESCRIPTION</th> <th>QTY.</th> </tr> </thead> <tbody> <tr> <td>4128</td> <td>Aluminum, Bag</td> <td>1</td> </tr> <tr> <td>4129</td> <td>Aluminum, Bulk</td> <td>100</td> </tr> </tbody> </table>	PART #	DESCRIPTION	QTY.	4128	Aluminum, Bag	1	4129	Aluminum, Bulk	100	 <table border="1"> <thead> <tr> <th>PART #</th> <th>DESCRIPTION</th> <th>QTY.</th> </tr> </thead> <tbody> <tr> <td>3082</td> <td>Nylon, Bag</td> <td>10</td> </tr> <tr> <td>3083</td> <td>Nylon, Bulk</td> <td>1000</td> </tr> </tbody> </table> <p>Colors: (1) White, (4) Black</p>	PART #	DESCRIPTION	QTY.	3082	Nylon, Bag	10	3083	Nylon, Bulk	1000	 <table border="1"> <thead> <tr> <th>PART #</th> <th>DESCRIPTION</th> <th>QTY.</th> </tr> </thead> <tbody> <tr> <td>3042</td> <td>White Nylon, Bag</td> <td>14</td> </tr> <tr> <td>3043</td> <td>White Nylon, Bulk</td> <td>100</td> </tr> </tbody> </table>	PART #	DESCRIPTION	QTY.	3042	White Nylon, Bag	14	3043	White Nylon, Bulk	100	 <table border="1"> <thead> <tr> <th>PART #</th> <th>DESCRIPTION</th> <th>QTY.</th> </tr> </thead> <tbody> <tr> <td>3040</td> <td>Nylon, Bag</td> <td>50</td> </tr> <tr> <td>3041</td> <td>Nylon, Bulk</td> <td>1000</td> </tr> </tbody> </table> <p>Colors: (1) White, (4) Black</p>	PART #	DESCRIPTION	QTY.	3040	Nylon, Bag	50	3041	Nylon, Bulk	1000
PART #	DESCRIPTION	QTY.																																																															
4124	1 1/4 in. projection, Bag	2																																																															
4125	1 1/4 in. projection, Bulk	100																																																															
4144	2 3/8 in. projection, Bag	2																																																															
4145	2 3/8 in. projection, Bulk	100																																																															
PART #	DESCRIPTION	QTY.																																																															
4126	Aluminum, Bag	2																																																															
4127	Aluminum, Bulk	100																																																															
PART #	DESCRIPTION	QTY.																																																															
4128	Aluminum, Bag	1																																																															
4129	Aluminum, Bulk	100																																																															
PART #	DESCRIPTION	QTY.																																																															
3082	Nylon, Bag	10																																																															
3083	Nylon, Bulk	1000																																																															
PART #	DESCRIPTION	QTY.																																																															
3042	White Nylon, Bag	14																																																															
3043	White Nylon, Bulk	100																																																															
PART #	DESCRIPTION	QTY.																																																															
3040	Nylon, Bag	50																																																															
3041	Nylon, Bulk	1000																																																															
BALL HEAD CARRIER	SNAP GLIDE	EYE SLIDE	SNAP TAPE	END STOP	END STOP WITH LOOP																																																												
 <table border="1"> <thead> <tr> <th>PART #</th> <th>DESCRIPTION</th> <th>QTY.</th> </tr> </thead> <tbody> <tr> <td>8120</td> <td>Acetal Plastic, Bag</td> <td>14</td> </tr> <tr> <td>8121</td> <td>Acetal Plastic, Bulk</td> <td>1000</td> </tr> </tbody> </table> <p>Colors: (1) White, (4) Black Note: Use with 3090 Snap Tape</p>	PART #	DESCRIPTION	QTY.	8120	Acetal Plastic, Bag	14	8121	Acetal Plastic, Bulk	1000	 <table border="1"> <thead> <tr> <th>PART #</th> <th>DESCRIPTION</th> <th>QTY.</th> </tr> </thead> <tbody> <tr> <td>3060</td> <td>Acetal Plastic, Bag</td> <td>14</td> </tr> <tr> <td>3061</td> <td>Acetal Plastic, Bulk</td> <td>1000</td> </tr> </tbody> </table> <p>Colors: (1) White, (4) Black</p>	PART #	DESCRIPTION	QTY.	3060	Acetal Plastic, Bag	14	3061	Acetal Plastic, Bulk	1000	 <table border="1"> <thead> <tr> <th>PART #</th> <th>DESCRIPTION</th> <th>QTY.</th> </tr> </thead> <tbody> <tr> <td>3050</td> <td>ABS Plastic, Bag</td> <td>50</td> </tr> <tr> <td>3051</td> <td>ABS Plastic, Bulk</td> <td>1000</td> </tr> </tbody> </table> <p>Colors: (1) White, (4) Black</p>	PART #	DESCRIPTION	QTY.	3050	ABS Plastic, Bag	50	3051	ABS Plastic, Bulk	1000	 <p>COLORS</p> <p>(3) Gray (4) Black (6) Off White</p> <table border="1"> <thead> <tr> <th>PART #</th> <th>DESCRIPTION</th> <th>QTY.</th> </tr> </thead> <tbody> <tr> <td>3090</td> <td>1 in. x 42 1/2 in., Bag</td> <td>1</td> </tr> <tr> <td>3091</td> <td>1 in. x 100 yards, Roll</td> <td>1</td> </tr> <tr> <td>3091Y</td> <td>1 in. x 1 yard, Bulk</td> <td>1</td> </tr> </tbody> </table> <p>Note: 4 1/4 in. Snap Spacing</p>	PART #	DESCRIPTION	QTY.	3090	1 in. x 42 1/2 in., Bag	1	3091	1 in. x 100 yards, Roll	1	3091Y	1 in. x 1 yard, Bulk	1	 <table border="1"> <thead> <tr> <th>PART #</th> <th>DESCRIPTION</th> <th>QTY.</th> </tr> </thead> <tbody> <tr> <td>3030</td> <td>Stainless Steel, Bag</td> <td>10</td> </tr> <tr> <td>3031</td> <td>Stainless Steel, Bulk</td> <td>1000</td> </tr> </tbody> </table> <p>Finishes: (8) Steel, (84) Black</p>	PART #	DESCRIPTION	QTY.	3030	Stainless Steel, Bag	10	3031	Stainless Steel, Bulk	1000	 <table border="1"> <thead> <tr> <th>PART #</th> <th>DESCRIPTION</th> <th>QTY.</th> </tr> </thead> <tbody> <tr> <td>3032</td> <td>White Nylon, Bag</td> <td>4</td> </tr> <tr> <td>3033</td> <td>White Nylon, Bulk</td> <td>100</td> </tr> </tbody> </table>	PART #	DESCRIPTION	QTY.	3032	White Nylon, Bag	4	3033	White Nylon, Bulk	100			
PART #	DESCRIPTION	QTY.																																																															
8120	Acetal Plastic, Bag	14																																																															
8121	Acetal Plastic, Bulk	1000																																																															
PART #	DESCRIPTION	QTY.																																																															
3060	Acetal Plastic, Bag	14																																																															
3061	Acetal Plastic, Bulk	1000																																																															
PART #	DESCRIPTION	QTY.																																																															
3050	ABS Plastic, Bag	50																																																															
3051	ABS Plastic, Bulk	1000																																																															
PART #	DESCRIPTION	QTY.																																																															
3090	1 in. x 42 1/2 in., Bag	1																																																															
3091	1 in. x 100 yards, Roll	1																																																															
3091Y	1 in. x 1 yard, Bulk	1																																																															
PART #	DESCRIPTION	QTY.																																																															
3030	Stainless Steel, Bag	10																																																															
3031	Stainless Steel, Bulk	1000																																																															
PART #	DESCRIPTION	QTY.																																																															
3032	White Nylon, Bag	4																																																															
3033	White Nylon, Bulk	100																																																															